

Article number: 0102219

Description: Retaining ring J410 DIN472
Spring steel

Measures

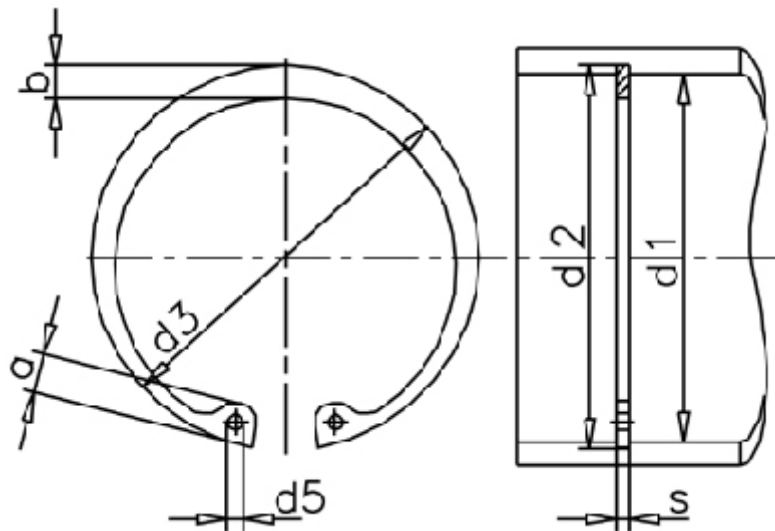

a max	=	FN kN	= 1307.00	t	= 6.00
AN mm ²	= 7842.0	FRg kN	= 150.0	tol	= +1,00
b	= 26.0	FR kN	= 1512.0	tol	= +2,00-1,00
d1	= 410	g	= 6.0	tol	= -0.15
d2	= 422.0	K kN-mm	= 3463.0	Tong	= ZGJ-5
d3	= 430.00	m min	= 7.20	Weight kg/1000	= 1380.00
d5 min	= 6.0	Nominal drive	= 18.0		
Description = J 410		s	= 7.00		